

**MEDIREX ID BANDS, LABELS & PAPER:
POSITIVE PATIENT IDENTIFICATION**

ID BANDS, LABELS & PAPER PRODUCT INFORMATION

499 Queen Street East
Toronto, Ontario M5A 1V1
Phone: +1 (416) 363-9313
Toll Free: 1 (800) 387-9848
www.medirexsys.com
www.positivepatient.ca

MEDIREX ID BANDS, LABELS & PAPER

ID BANDS, LABELS & PAPER PRODUCT INFORMATION

499 Queen Street East
Toronto, Ontario M5A 1V1
Phone: +1 (416) 363-9313
Toll Free: 1 800 387-9848
www.medirexsys.com
www.positivepatient.ca

Contents

5–16	SuperSoft Patient ID Bands 8500L, 8500RL, 8500, 8500R, 8600G, 8608G, 8512, 8512R, 8501X, 8501R, 8620G, 8501P
18–21	Laser Printed Labels 7108, 7115, 7706, 7754
23–26	Thermal Printed Bands 4011, 4013, 4023, 4031
28–31	Thermal Printed Labels 4012, 4041, 4043, 4044
33–34	Vinyl Bands 4005, 4006
36–38	Poly Bands 4021, 4040
40	EcoPaper Bands 4002
41–45	Carbonless Paper 7902, 7903, 7904, 7905, 7915

SuperSoft ID Bands

Hospital Benefits

- Tamper evident
- No latex or phthalates in product
- Highly water and chemical resistant
- Can be worn by acute care patients for up to 30 days
- Very well priced/economical
- Multiple armband + label combinations available
- Prints from standard laser printer
- Very simple and quick to apply to patient
- Large area for patient demographic information and barcodes (1D & 2D)
- Various colours available
- Little staff training required
- Compatible with Medirex Print Server Software

Patient Benefits

- Softest band in the market place
- Very comfortable: very thin, light-weight, and no pressure on skin
- Non-Allergenic

MEDIREX ID BANDS, LABELS & PAPER

PRODUCT INFORMATION

Band Only

Model #: 8500L
SuperSoft ID Band

LASER PRINTABLE

- Supersoft ID Band Only

Adult Armband: 10.5" Long and 1.0" Wide

Patient Information Area: 6.5" Long and 1.0" Wide

Product No.	Colour	Product Dimensions
8500L	White	11" (length) x 3.5" (width)

Functional Equivalent for (by Current PDC Supplier Code):

3080-11-PDR, 3080-13-PDR, 3080-17-PDR, 5140-11-PDM, 6500-11-PDM, 6505-29-PDM, 6708-10-PDL, 6709-10-PDL, 6722-10-PDH, 6749-10-PDH, 6821-17-PDL, 6823-17-PDL, 6825-17-PDH, 7022-17-PDM, 7024-17-PDH, 7024S-17-PDH, 7041-11-PDM, 7043-13-PDH, 7043-17-PDH, 7043S-11-PDH, 7045-17-PDL, 7046-11-PDL, 7046-17-PDL, 7055-17-PDO, 7340-11-PDM, 7342-17-PDM, 821-11-PDJ, 821-17-PDJ, 825-11-PDJ, 825-17-PDJ, 841-11-PDJ, 841-17-PDJ, 845-11-PDJ, 845-17-PDJ, 851-11-PDJ, 851-17-PDJ, 881-11-PDJ, 881-17-PDJ, 9350-11-PDL, TM-IND-02A

○
○
○
○
○
○
○

Medirex

To Re-order Form # 8500L: Tel: 1-800-387-9848,
Fax: 1-800-301-1139, Email: medsales@medirexsys.com

Step 1
Pull band up, off the sheet using unadhered side between **A** and **B**.

Step 2
Wrap **B** tightly but comfortably around wrist, and adhere to underside of band.

Step 3
Fold tab **B** inward so the band doubles over itself and the **A** is facing up.

Step 4
Finish by joining tab **A** to the rest of the band.

Patent-Pending

Notes:

MEDIREX ID BANDS, LABELS & PAPER

PRODUCT INFORMATION

Band Only + Alert Border

Model #: 8500RL
SuperSoft ID Band

LASER PRINTABLE

- Supersoft ID Band Only
- Alert Colouring (Red)

Adult Armband: 10.5" Long and 1.0" Wide
 Patient Information Area: 6.5" Long and 1.0" Wide

Product No.	Colour	Product Dimensions
8500RL	White	11" (length) x 3.5" (width)

Functional Equivalent for (by Current PDC Supplier Code):
 7022-16-PDM, 7042-16-PDM, 7045-16-PDL, 7046-16-PDL, 7052-16-PDH, 7054-16-PDO

○
○
○
○
○
○
○

Medirex
To Re-order Form # 8500RL: Tel: 1-800-387-9848,
 Fax: 1-800-301-1139, Email: medsales@medirexsys.com

Step 1
Pull band up, off the sheet using unadhered side between A and B.

Step 2
Wrap B tightly but comfortably around wrist, and adhere to underside of band.

Step 3
Fold tab B inward so the band doubles over itself and the A is facing up.

Step 4
Finish by joining tab A to the rest of the band.

Patent-Pending

Notes:

MEDIREX ID BANDS, LABELS & PAPER

PRODUCT INFORMATION

Band Only + Green Border

Model #: 8600G
SuperSoft ID Band

LASER PRINTABLE

- Supersoft ID Band Only
- Designed for Outpatients

Product No.	Colour	Product Dimensions
8600G	White	11" (length) x 3.5" (width)

Adult Armband: 10.5" Long and 1.0" Wide
 Patient Information Area: 6.5" Long and 1.0" Wide

○
○
○
○
○
○
○

Medirex
To Re-order Form # 8600G: Tel: 1-800-387-9848,
 Fax: 1-800-301-1139, Email: medsales@medirexsys.com

Step 1
 Pull band up, off the sheet using unadhered side between **A** and **B**.

Step 2
 Wrap **B** tightly but comfortably around wrist, and adhere to underside of band.

Step 3
 Fold tab **B** inward so the band doubles over itself and the **A** is facing up.

Step 4
 Finish by joining tab **A** to the rest of the band.

Patent-Pending

Notes:

MEDIREX ID BANDS, LABELS & PAPER

PRODUCT INFORMATION

Band with 4 Labels Model #: 8500 *SuperSoft ID Band*

LASER PRINTABLE

- Supersoft ID Band.
- 4 Laser printable labels.

Product No.	Colour	Product Dimensions
8500	White	11" (length) x 4.25" (width)

Adult Armband: 10.5" Long and 1.0" Wide
 Patient Information Area: 6.5" Long and 1.0" Wide
 Labels: 4 X 2.5" Long and 1.0" Wide

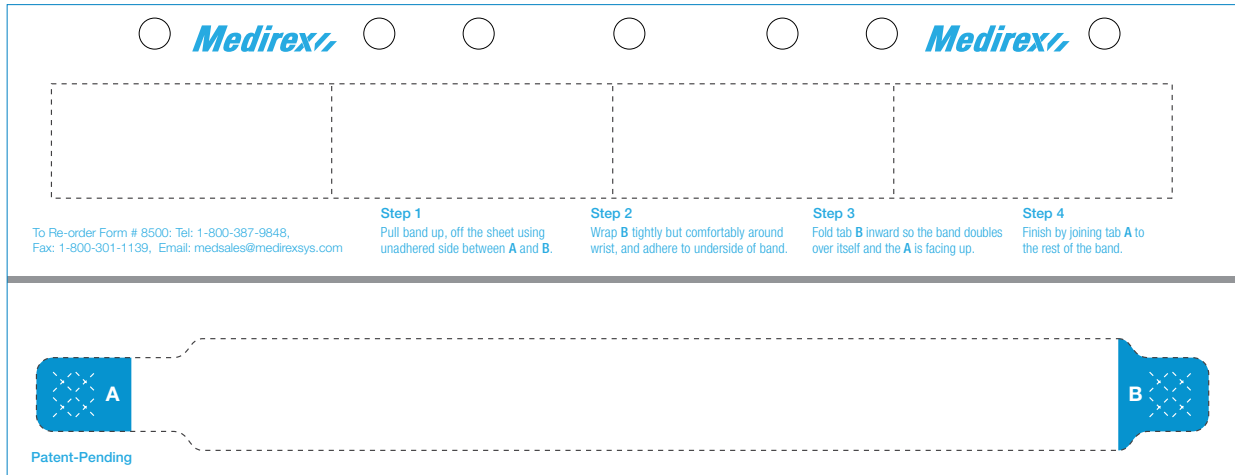

Notes:

MEDIREX ID BANDS, LABELS & PAPER

PRODUCT INFORMATION

Band with 4 Labels + Alert Border

Model #: 8500R
SuperSoft ID Band

LASER PRINTABLE

- Supersoft ID Band.
- 4 Laser printable labels
- Alert Colouring (Red)

Product No.	Colour	Product Dimensions
8500R	White	11" (length) x 4.25" (width)

Adult Armband: 10.5" Long and 1.0" Wide

Patient Information Area: 6.5" Long and 1.0" Wide

Labels: 4 X 2.5" Long and 1.0" Wide

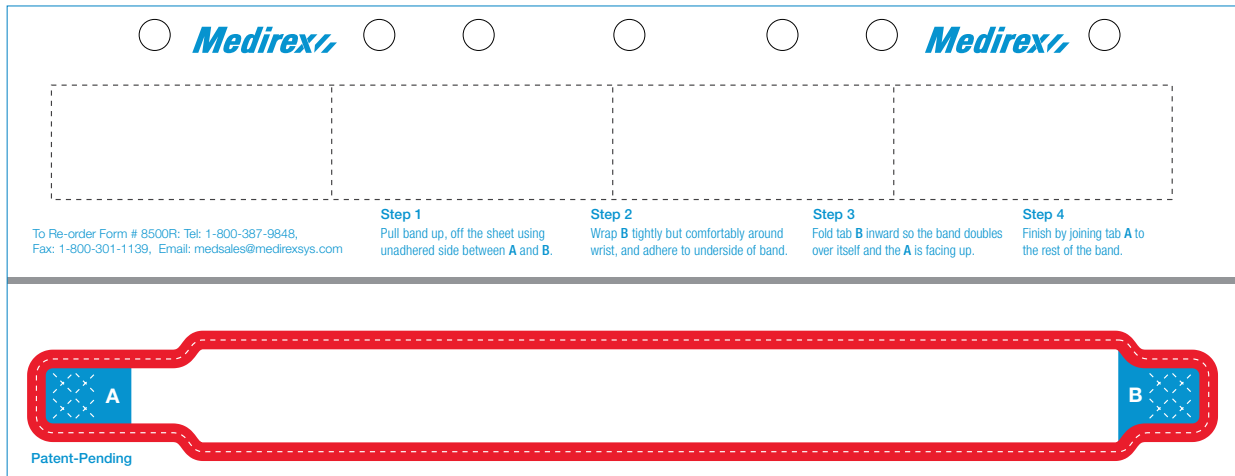

Notes:

MEDIREX ID BANDS, LABELS & PAPER

PRODUCT INFORMATION

Band with 8 Labels + Green Border

Model #: 8608G
SuperSoft ID Band

LASER PRINTABLE

- SuperSoft ID Bands
- 8 Laser printable labels
- Designed for Outpatients

Product No.	Colour	Product Dimensions
8608G	White	11" (length) x 4.25" (width)

Adult Armband: 10.5" Long and 1.0" Wide
 Patient Information Area: 6.5" Long and 1.0" Wide
 Labels: 8 X 2.5" Long and 1.0" Wide

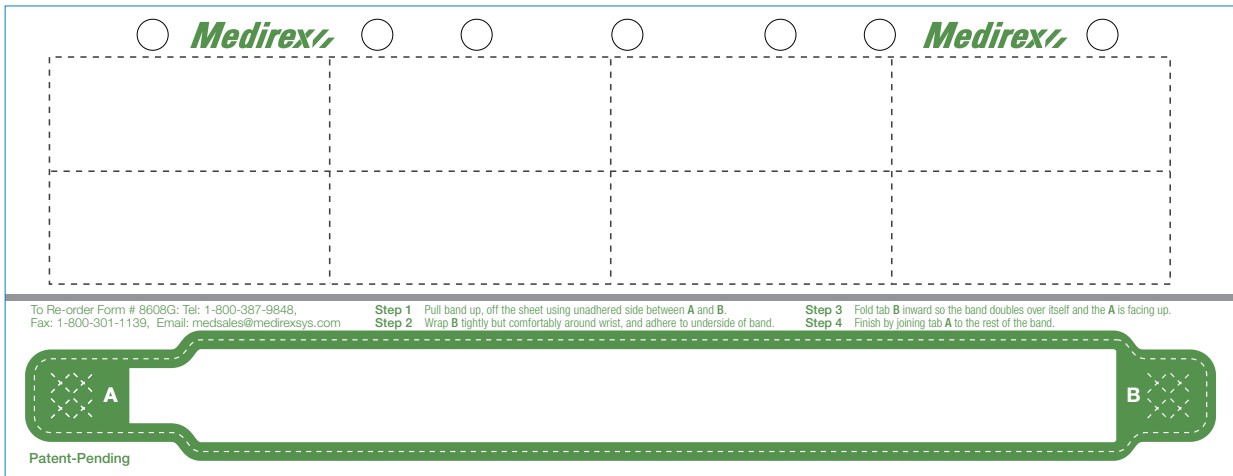

Notes:

MEDIREX ID BANDS, LABELS & PAPER

PRODUCT INFORMATION

Band with 12 Labels Model #: 8512 *SuperSoft ID Band*

LASER PRINTABLE

- Supersoft ID Band.
- 12 Laser printable labels

Adult Armband: 10.5" Long and 1.0" Wide
Patient Information Area: 6.5" Long and 1.0" Wide
Labels: 12 X 2.5" Long and 1.0" Wide

Product No.	Colour	Product Dimensions
8512	White	11" (length) x 5.83" (width)

To Re-order Form # 8512; Tel: 1-800-387-9849, Fax: 1-800-301-1139, Email: medsales@medirexsys.com

Step 1
Pull band up, off the sheet using unadhered side between **A** and **B**.

Step 2
Wrap **B** tightly but comfortably around wrist, and adhere to underside of band.

Step 3
Fold tab **B** inward so the band doubles over itself and the **A** is facing up.

Step 4
Finish by joining tab **A** to the rest of the band.

Patent-Pending

Notes:

MEDIREX ID BANDS, LABELS & PAPER

PRODUCT INFORMATION

Band with 12 Labels + Alert Border

Model #: 8512R
SuperSoft ID Band

LASER PRINTABLE

- Supersoft ID Band.
- 12 Laser printable labels
- Alert Colouring (Red)

Product No.	Colour	Product Dimensions
8512R	White	11" (length) x 5.83" (width)

Adult Armband: 10.5" Long and 1.0" Wide
 Patient Information Area: 6.5" Long and 1.0" Wide
 Labels: 12 X 2.5" Long and 1.0" Wide

To Re-order Form # 8512R; Tel: 1-800-387-9848, Fax: 1-800-301-1139, Email: medsales@medirexsys.com

Step 1
Pull band up, off the sheet using unadhered side between **A** and **B**.

Step 2
Wrap **B** tightly but comfortably around wrist, and adhere to underside of band.

Step 3
Fold tab **B** inward so the band doubles over itself and the **A** is facing up.

Step 4
Finish by joining tab **A** to the rest of the band.

Patent-Pending

Notes:

MEDIREX ID BANDS, LABELS & PAPER

PRODUCT INFORMATION

Band with 20 Labels

Model #: 8501X
SuperSoft ID Band

LASER PRINTABLE

- Supersoft ID Band.
- 20 Laser printable labels

Adult Armband: 10.5" Long and 1.0" Wide
 Patient Information Area: 6.5" Long and 1.0" Wide
 Labels: 20 X 2.5" Long and 1.0" Wide

Product No.	Colour	Product Dimensions
8501X	White	11" (length) x 8.5" (width)
Functional Equivalent for (by Current PDC Supplier Code):		
9200-00-PDM, 9310-00-PDR, 9311-00-PDR, 9325-11-PDR, 9500-11-PDR, 9502-11-PDR		

The diagram shows a white rectangular band template with a grid of 20 labels (4 columns by 5 rows). The top edge features the Medirex logo and two punch holes. The right edge has five punch holes. Below the grid, four steps are provided for assembly:

- Step 1:** Pull band up, off the sheet using unadhered side between A and B.
- Step 2:** Wrap B tightly but comfortably around wrist, and adhere to underside of band.
- Step 3:** Fold tab B inward so the band doubles over itself and the A is facing up.
- Step 4:** Finish by joining tab A to the rest of the band.

At the bottom, a detailed view of the band's ends shows two tabs, A and B, with a dashed line indicating the fold line. The text "Patent-Pending" is located below tab A.

Notes:

MEDIREX ID BANDS, LABELS & PAPER

PRODUCT INFORMATION

Band with 20 Labels + Alert Border

Model #: 8501R
SuperSoft ID Band

LASER PRINTABLE

- Supersoft ID Band.
- 20 Laser printable labels
- Alert Colouring (Red)

Product No.	Colour	Product Dimensions
8501R	White	11" (length) x 8.5" (width)

Adult Armband: 10.5" Long and 1.0" Wide
 Patient Information Area: 6.5" Long and 1.0" Wide
 Labels: 20 X 2.5" Long and 1.0" Wide

The diagram shows a template for the Medirex ID band. At the top, there are two Medirex logos flanked by circles. Below this is a grid of 20 rectangular labels arranged in 4 rows and 5 columns, separated by dashed lines. To the right of the grid are four circles. Below the grid, there are four steps for assembly:

Medirex
 To Re-order Form # 8501R: Tel: 1-800-387-9848, Fax: 1-800-301-1139, Email: medsales@medirexsys.com

Step 1
 Pull band up, off the sheet using unadhered side between **A** and **B**.

Step 2
 Wrap **B** tightly but comfortably around wrist, and adhere to underside of band.

Step 3
 Fold tab **B** inward so the band doubles over itself and the **A** is facing up.

Step 4
 Finish by joining tab **A** to the rest of the band.

Below the instructions is a diagram of the assembled band, which is red with a dashed border. It has two tabs labeled **A** and **B** at the ends. The text "Patent-Pending" is written below this diagram.

Notes:

MEDIREX ID BANDS, LABELS & PAPER PRODUCT INFORMATION

Band with 20 Labels + Green Border Model #: 8620G *SuperSoft ID Band*

LASER PRINTABLE

- SuperSoft ID Bands
- 20 Laser printable labels
- Designed for Outpatients

Adult Armband: 10.5" Long and 1.0" Wide
Patient Information Area: 6.5" Long and 1.0" Wide
Labels: 20 X 2.5" Long and 1.0" Wide

Product No.	Colour	Product Dimensions
8620G	White	11" (length) x 8.5" (width)

The diagram shows a sheet of paper with a grid of 20 labels (4 columns by 5 rows). The labels are separated by dashed lines. At the top of the sheet, there are two 'Medirex' logos, each flanked by a circle. On the right side of the grid, there are four circles. Below the grid, there is a green border with two tabs labeled 'A' and 'B'. The text 'Patent-Pending' is located below the green border.

Medirex

To Re-order Form # 8620G: Tel: 1-800-387-9848, Fax: 1-800-301-1139, Email: medsales@medirexsys.com

Step 1
Pull band up, off the sheet using unadhered side between **A** and **B**.

Step 2
Wrap **B** tightly but comfortably around wrist, and adhere to underside of band.

Step 3
Fold tab **B** inward so the band doubles over itself and the **A** is facing up.

Step 4
Finish by joining tab **A** to the rest of the band.

A **B**

Patent-Pending

Notes:

MEDIREX ID BANDS, LABELS & PAPER PRODUCT INFORMATION

2 Adult Bands, 4 Infant Bands & 3 ID Cards Model #: 8501P *SuperSoft ID Band*

LASER PRINTABLE

- SuperSoft ID Bands: 4 infant & 2 adult
- 3 Family ID Cards
- Laser printable

Adult Armband: 10.5" Long and 1.0" Wide
Patient Information Area: 6.5" Long and 1.0" Wide

Infant Armband: 7.125" Long and 0.75" Wide
Patient Information Area: 5.5" Long and 0.75" Wide

ID Cards: 3 X 3.375" Long and 1.5" Wide

Product No.	Colour	Product Dimensions
8501P	White	11" (length) x 8.5" (width)
Functional Equivalent for (by Current PDC Supplier Code):		
6773-14-PDL, 6775-43-PDL, 9204-00-PDR, 9510-11-PDM, TM-MFB-02A		

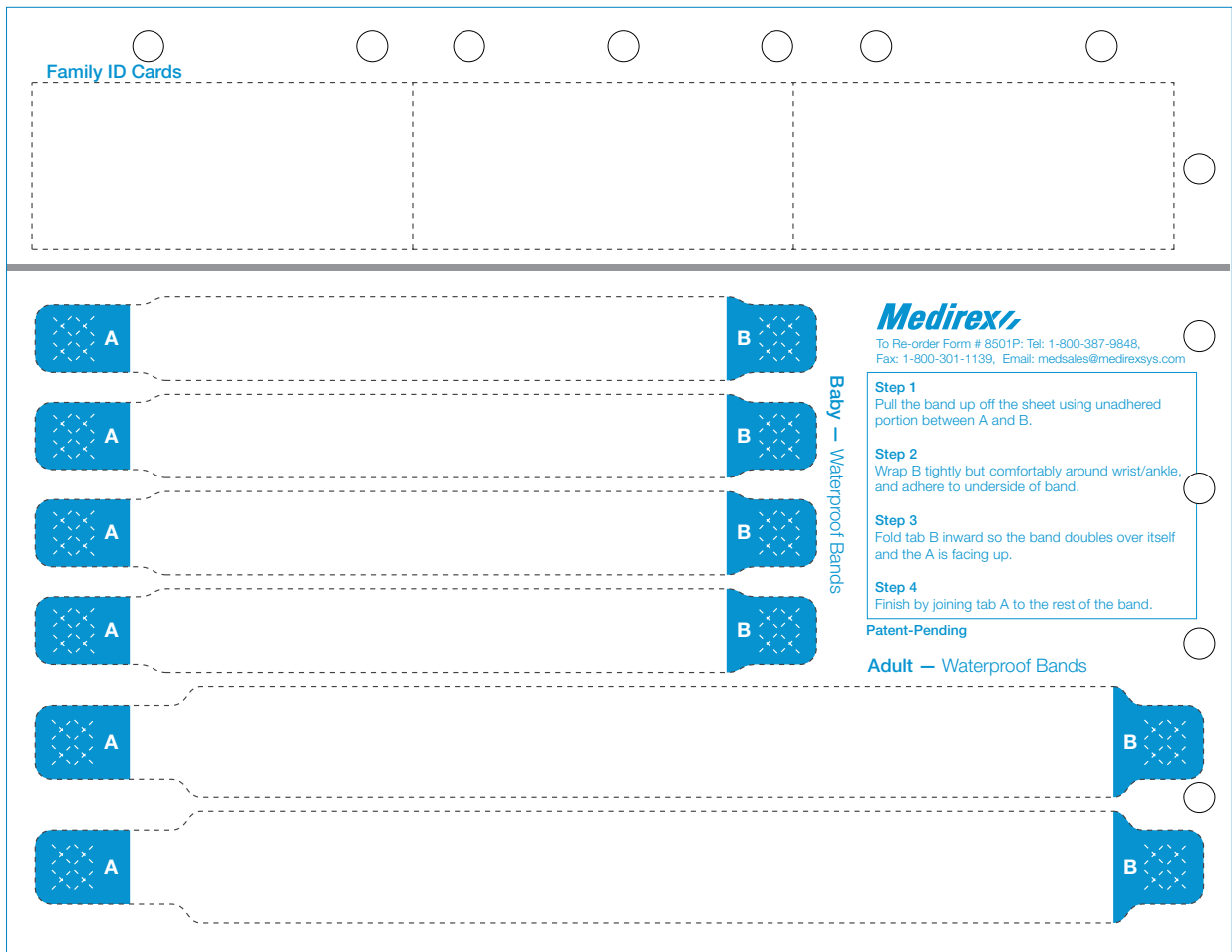

Notes:

Laser Printed Labels

Priced Competitively

Varying sizes and layout to accommodate
all healthcare processes

Compatible with Medirex Print Server Software

MEDIREX ID BANDS, LABELS & PAPER

PRODUCT INFORMATION

13 Labels
Model #: 7108
Laser Printed Labels

LASER PRINTABLE

- 13 Laser Printable Labels

Labels: 10 X 2.500" Long and 1.150" Wide
Labels: 3 X 3.150" Long and 1.850" Wide

Product No.	Colour	Product Dimensions
7108	White	8.25" (length) x 5.83" (width)

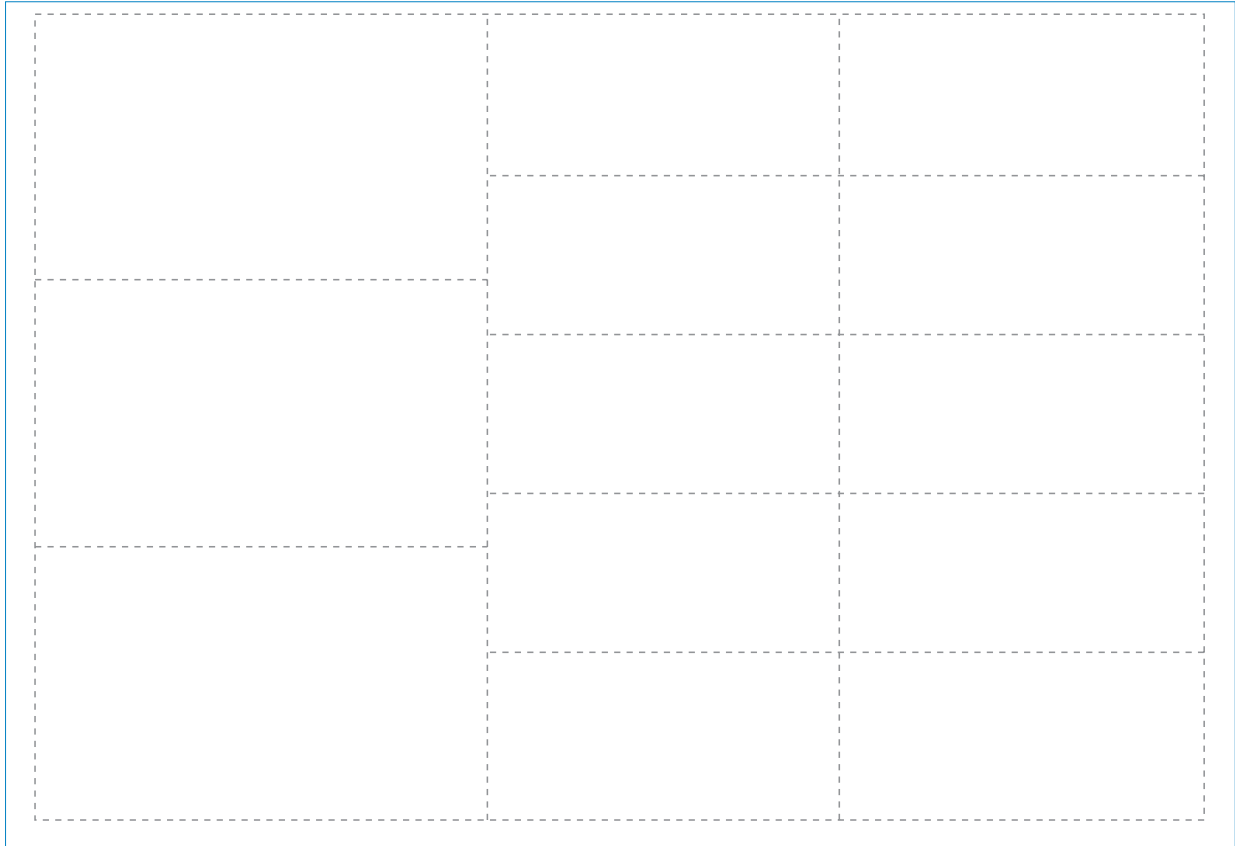

Notes:

MEDIREX ID BANDS, LABELS & PAPER

PRODUCT INFORMATION

15 Labels
Model #: 7115
Laser Printed Labels

LASER PRINTABLE

- 15 Laser Printable Labels

Labels: 15 X 2.500" Long and 1.000" Wide

Product No.	Colour	Product Dimensions
7115	White	8.25" (length) x 5.83" (width)

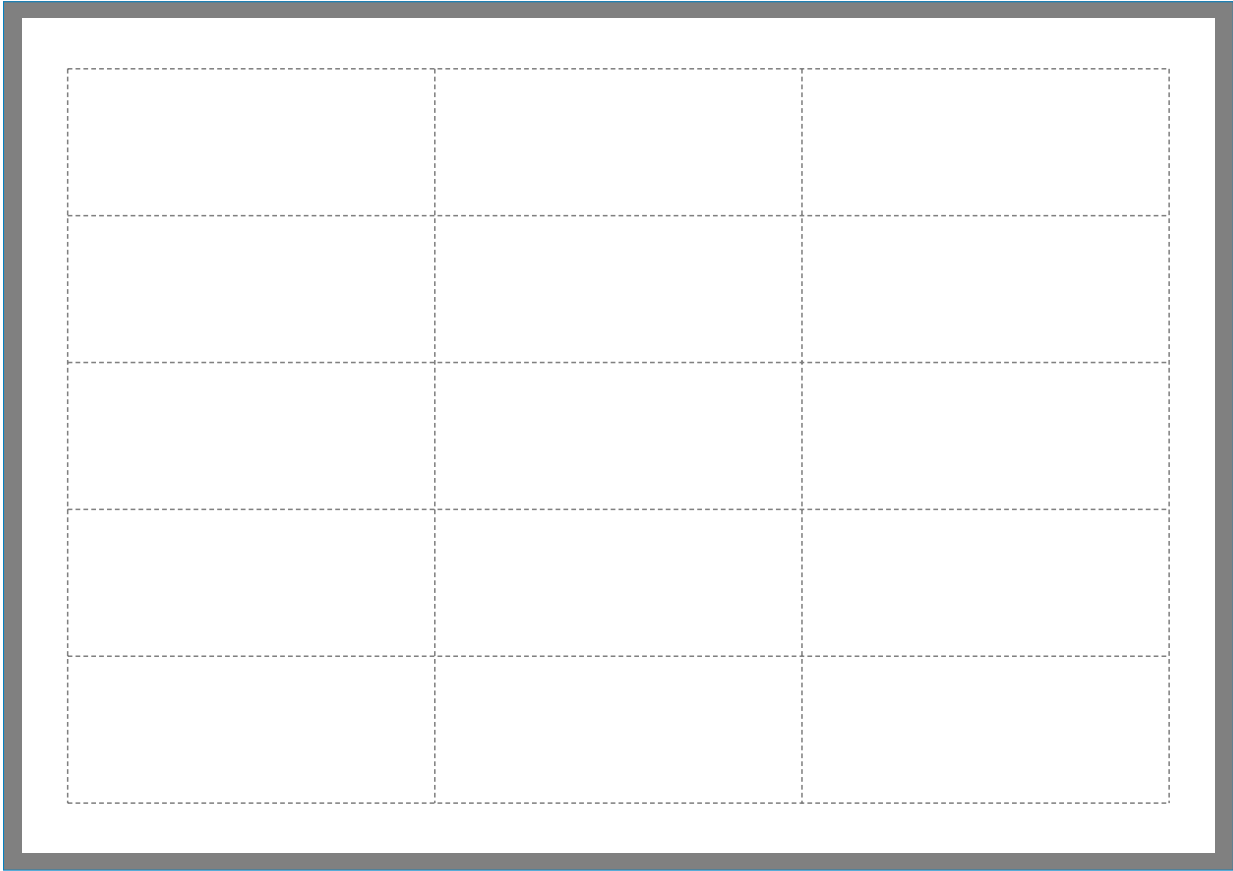

Notes:

MEDIREX ID BANDS, LABELS & PAPER

PRODUCT INFORMATION

30 Labels
Model #: 7706
Laser Printed Labels

LASER PRINTABLE

- 30 Laser Printable Label Sheet with punched holes

Labels: 30 X 2.500" Long and 1.000" Wide

Product No.	Colour	Current Supplier Code
7706	White	8.5" (length) x 11" (width)
Functional Equivalent for (by Current PDC Supplier Code): 9105-00NH-PDR, TM-ADMIT-02, WBW-AX51, WBW-AX73		

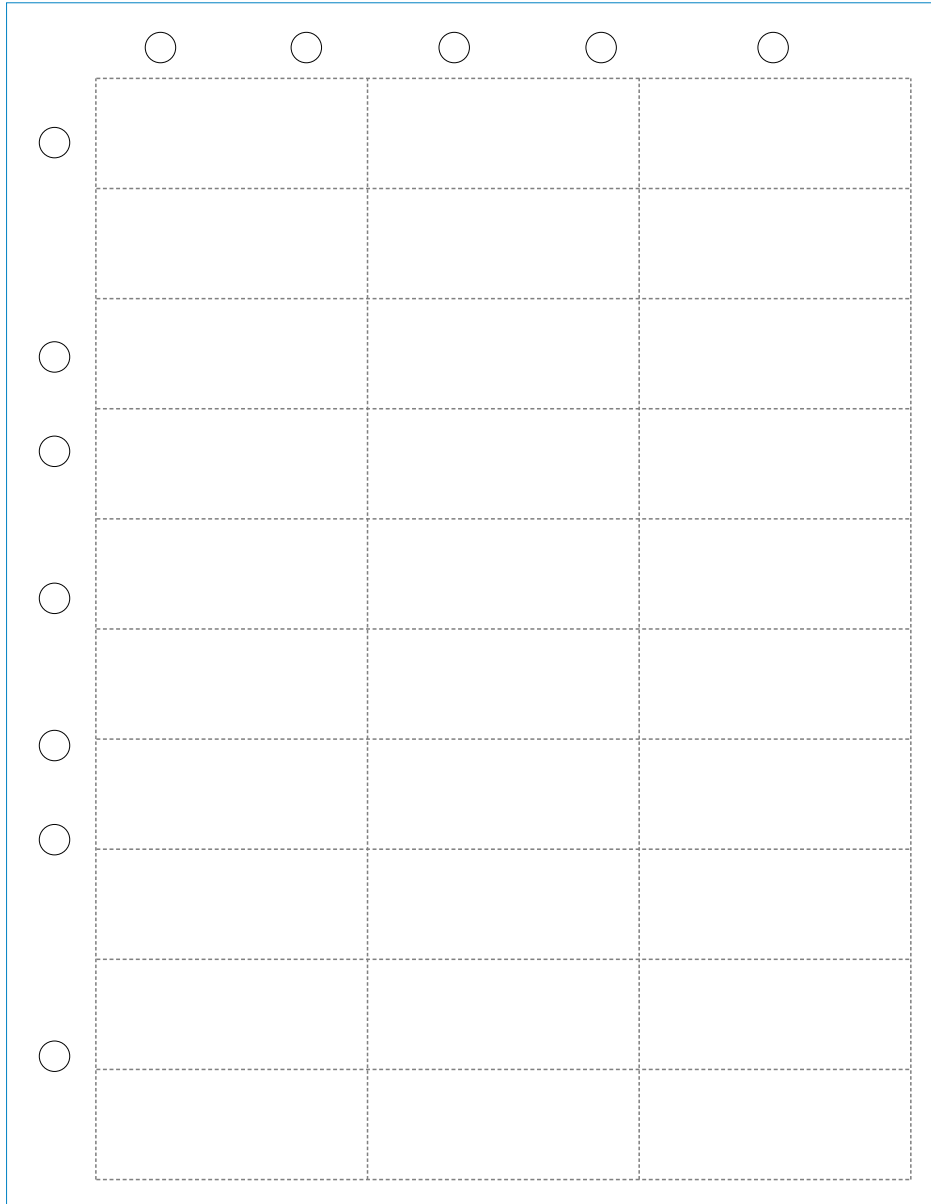

Notes:

MEDIREX ID BANDS, LABELS & PAPER

PRODUCT INFORMATION

54 Labels

Model #: 7754

Laser Printed Labels

COLOUR LABEL SET

- 54 Total Coloured Labels
- 24 Red
- 12 Yellow
- 6 Purple
- 6 Dark Green
- 6 Pink

Labels: 54 X 0.750" Long and 0.750" Wide

Product No.	Colour	Product Dimensions
7754	Red	8.25" (length) x 5.83" (width), 0.75" (diameter) Dots
	Yellow	
	Purple	
	Green	
	Pink	

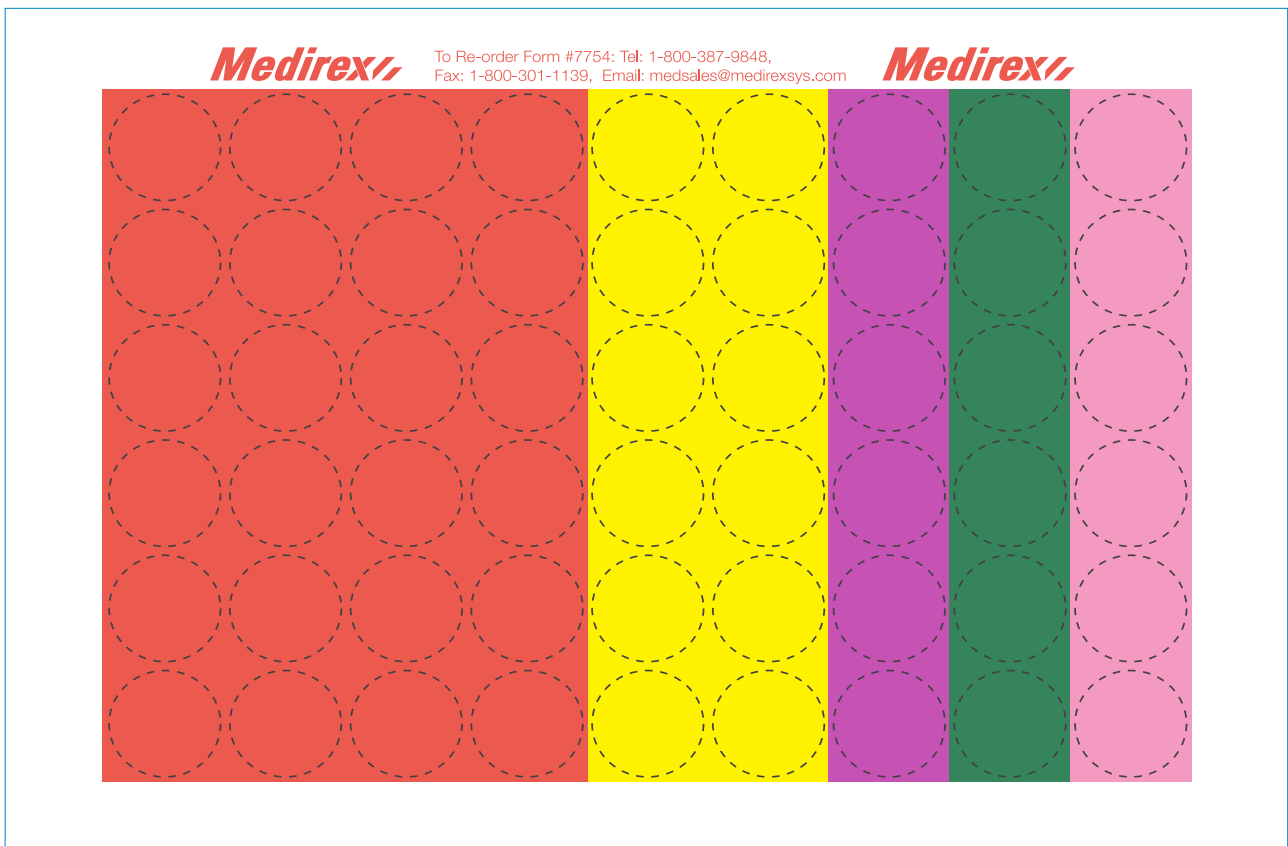

Notes:

Thermal Printed Bands

Tamper evident

Water resistant

Prints from many makes and models of direct thermal transfer printers with correct width capability, using black bar technology regardless of Outer Dimensions or Core Size

Large-area for patient demographic information and barcodes (1D & 2D)

Multiple colour choices

Compatible with Medirex Print Server Software

MEDIREX ID BANDS, LABELS & PAPER

PRODUCT INFORMATION

Infant Band Model #: 4011 *Thermal Printed Band*

DIRECT THERMAL

- Various core and outer dimension sizes
- Tamper-evident adhesive closure with black bar sensor
- Direct thermal armband provides accurate 1D and 2D bar-codes

—
Infant Armband: 6.75" Long and 0.825" Wide

Patient Information Area: 2.75" Long and 0.825" Wide

Product No.	Colour	Product Dimensions
4011-WH	White	6.75" (length) x 0.825" (width)

Functional Equivalent for (by Current PDC Supplier Code):
7701-11-PDL, 7701-49-PDL, TM-AB-19227



Notes:

MEDIREX ID BANDS, LABELS & PAPER

PRODUCT INFORMATION

Adult Band + Infant Band Model #: 4031-WH *Thermal Printed Band*

DIRECT THERMAL

- Various core and outer dimension sizes
- Tamper-evident adhesive closure with black bar sensor
- Direct thermal armband provides accurate 1D & 2D bar-codes

Adult Armband: 10.125" Long and 1.125" Wide
Patient Information Area: 3.875" Long and 1.125" Wide

Infant Armband: 6.75" Long and 0.825" Wide
Patient Information Area: 2.75" Long and 0.825" Wide

Product No.	Colour	Product Dimensions
4031-WH	White	10.125" (length) x 1.95" (width)
Functional Equivalent for (by Current PDC Supplier Code):		
7750-11-PDO		

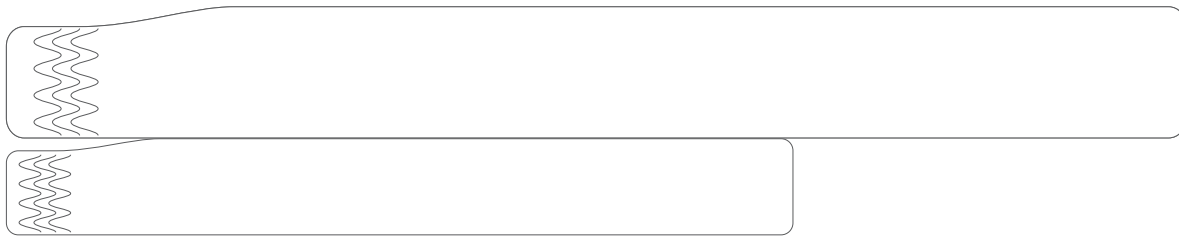

Notes:

MEDIREX ID BANDS, LABELS & PAPER

PRODUCT INFORMATION

2 Adult Bands & 2 Infant Bands

Model #: 4013

Thermal Printed Band

DIRECT THERMAL

- Various core and outer dimension sizes.
- Tamper-evident adhesive closure with black bar sensor.
- Direct thermal armband provides accurate 1D & 2D bar-codes.

Adult Armband: 10.125" Long and 1.125" Wide

Patient Information Area: 3.875" Long and 1.125" Wide

Infant Armband: 6.750" Long and 0.825" Wide

Patient Information Area: 2.75" Long and 0.825" Wide

Product No.	Colour	Product Dimensions
4013-WH	White	3.9" (length) x 10.125" (width)
Functional Equivalent for (by Current PDC Supplier Code):		
7744-11-PDL		

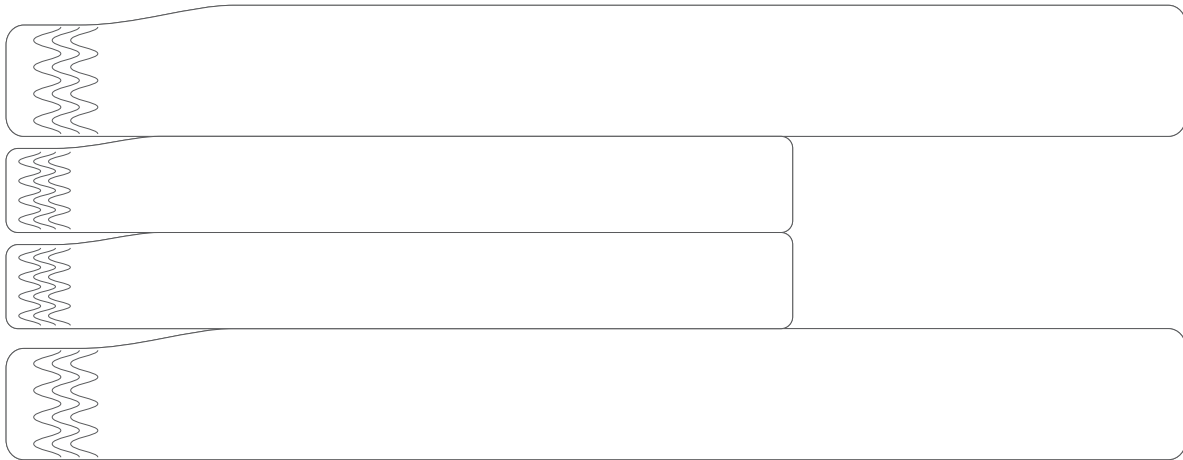

Notes:

MEDIREX ID BANDS, LABELS & PAPER

PRODUCT INFORMATION

Adult Band Model #: 4023 Thermal Printed Band

DIRECT THERMAL

- Various core and outer dimension sizes
- Tamper-evident adhesive closure with black bar sensor
- Direct thermal armband provides accurate 1D & 2D bar-codes

Adult Armband: 10.125" Long and 1.125" Wide

Patient Information Area: 5.0" Long and 1.125" Wide

Product No.	Colour	Product Dimensions
4023-WH	White ○	10.125" (length) x 1.125" (width)
4023-YE	Yellow ●	10.125" (length) x 1.125" (width)
4023-GR-L	Light Green ●	10.125" (length) x 1.125" (width)
4023-BL-L	Light Blue ●	10.125" (length) x 1.125" (width)
4023-BL-D	Dark Blue ●	10.125" (length) x 1.125" (width)

Functional Equivalent for (by Current PDC Supplier Code):

○	7022-11-PDM, 7042-11-PDM, 7045-11-PDL, 7046-11-PDL, 7052-11-PDH, 7054-11-PDO, 7343-11-PDM, TM-AB-29295
●	7022-14-PDM, 7042-14-PDM, 7045-14-PDL, 7046-14-PDL, 7054-14-PDO, 7343-14-PDM
●	7022-15-PDM, 7042-15-PDM, 7045-15-PDL, 7046-15-PDL, 7054-15-PDO, 7343-15-PDM
●	7022-13-PDM, 7042-13-PDM, 7045-13-PDL, 7046-13-PDL, 7052-13-PDH
●	7054-13-PDO, 7343-13-PDM



Notes:

Thermal Printed Labels

Priced Competitively

Multiple Core sizes

Multiple Roll diameters

Compatible with Medirex Print Server Software

MEDIREX ID BANDS, LABELS & PAPER

PRODUCT INFORMATION

Labels (Roll)

Model #: 4012

Thermal Printed Label

DIRECT THERMAL

- Various core and outer dimension sizes
- Direct thermal printable water resistant labels with bar-codes print capability
- Permanent adhesive
- Tamper-evident marks with black bar sensor
- 200 Labels to a Roll

Labels: 3.25" Long and 0.825" Wide
Product Shown at Actual Size

Product No.	Colour	Product Dimensions
4012	White	3.25" (length) x 0.825" (width)
Functional Equivalent for (by Current PDC Supplier Code):		
9130-00-PDR, 9132-00-PDR		

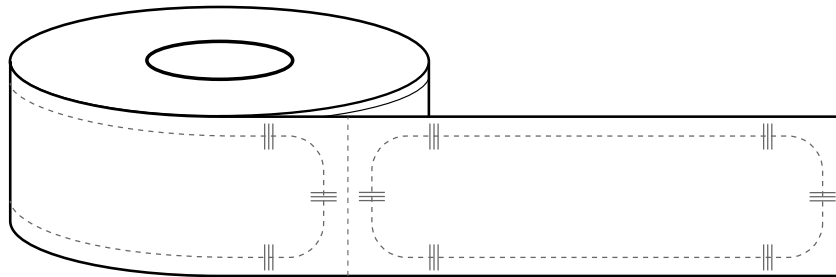

Notes:

MEDIREX ID BANDS, LABELS & PAPER

PRODUCT INFORMATION

Labels (Roll)

Model #: 4041

Thermal Printed Label

DIRECT THERMAL

- Direct thermal printable labels with bar-code print capability
- Permanent adhesive
- 1.0" Core and 3.875" Outer Dimension
- 1,100 Labels to a Roll
- Ideal for use in Laboratory & Pharmacy

Labels: 1.500" Long and 2.000" Wide
Product Shown at Actual Size

Product No.	Colour	Product Dimensions
4041	White	1.5" (length) x 2.0" (width)

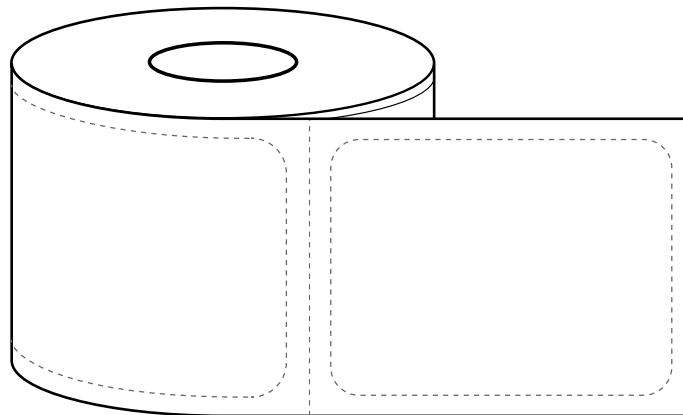

Notes:

MEDIREX ID BANDS, LABELS & PAPER

PRODUCT INFORMATION

Continuous Label (Roll) Model #: 4043 *Thermal Printed Label*

DIRECT THERMAL

- 1" Core
- Direct thermal printable labels with bar-codes print capability
- Permanent adhesive
- No Die Cut or Back Slit
- 1,800" continuous Label on Roll

Labels: 1,800" Long and 4.000" Wide

Product No.	Colour	Product Dimensions
4043	White	1,800" (length) x 4" (width)

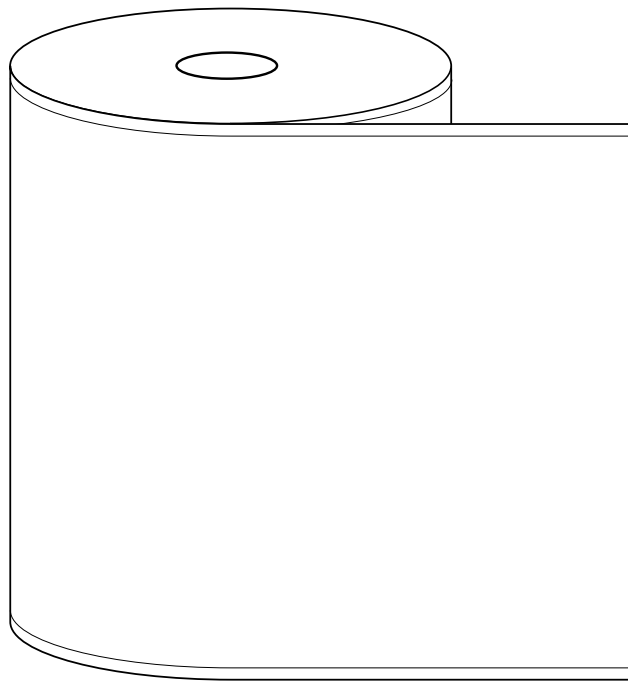

Notes:

MEDIREX ID BANDS, LABELS & PAPER

PRODUCT INFORMATION

Labels (Roll)

Model #: 4044

Thermal Printed Label

DIRECT THERMAL

- 1" Core
- Direct thermal printable labels with bar-codes print capability
- Permanent adhesive
- 300 Labels to a Roll

Labels: 6.000" Long and 4.000" Wide

Product No.	Colour	Product Dimensions
4044	White	6.000" (length) x 4.000" (width)

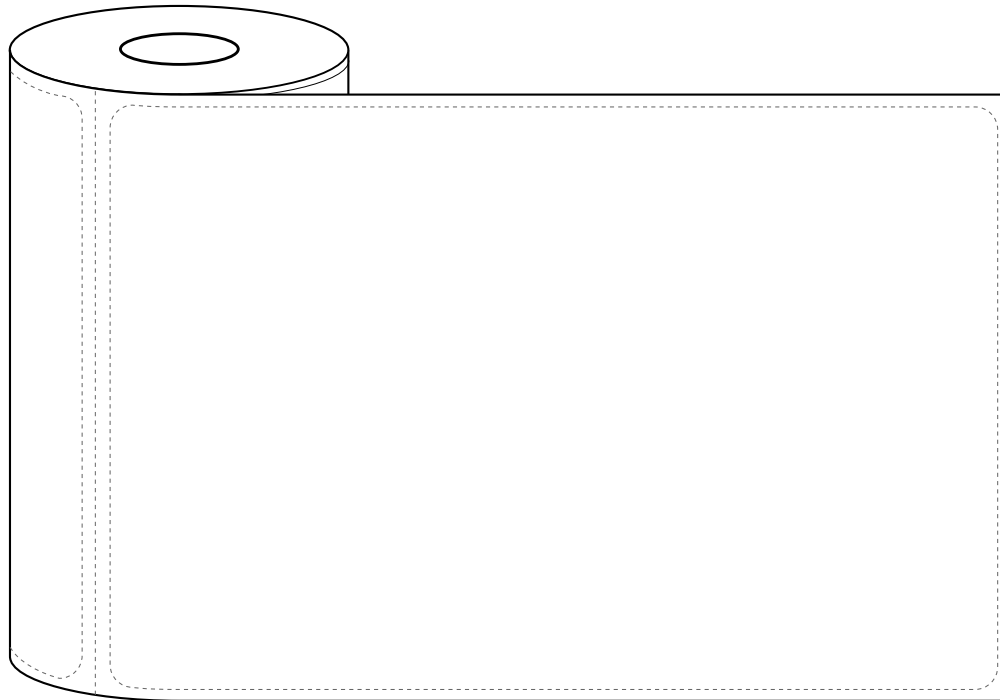

Notes:

Vinyl Bands

Tamper evident & Water resistant
Requires no specific printer hardware
Large-area for patient demographic information and
barcodes (1D & 2D) label to be applied
Latex Free
Multiple colour choices

MEDIREX ID BANDS, LABELS & PAPER

PRODUCT INFORMATION

Adult Band with Snap Closure

Model #: 4005

Vinyl Band

VINYL

- Soft straight wave vinyl armband with snap closure.
- Latex free.
- Allows for written information and for imprinting and label applications.

Adult Armband: 10.000" Long and 0.625" Wide
 Patient Information Area: 4.000" Long and 0.625" Wide

Product No.	Colour		Product Dimensions
4005-WH	White	○	10.00" (length) x 0.625" (width)
4005-RE	Red	●	10.00" (length) x 0.625" (width)
4005-YE	Yellow	●	10.00" (length) x 0.625" (width)
4005-GR-L	Light Green	●	10.00" (length) x 0.625" (width)
4005-GR-D	Dark Green	●	10.00" (length) x 0.625" (width)
4005-BL-L	Light Blue	●	10.00" (length) x 0.625" (width)
4005-PU	Purple	●	10.00" (length) x 0.625" (width)
4005-PI	Pink	●	10.00" (length) x 0.625" (width)
4005-OR	Orange	●	10.00" (length) x 0.625" (width)

Functional Equivalent for (by Current PDC Supplier Code):

○	130P-92-PDM-I
●	440-16-PDM, 520-16-PDM, 540-16-PDM
●	520-14-PDM, 540-14-PDM
●	130S-15-PDM
●	520-22-PDM, 540-22-PDM
●	130S-18-PDM, 520-13-PDM, 540-13-PDM
●	520-17-PDM, 540-17-PDM



Notes:

MEDIREX ID BANDS, LABELS & PAPER

PRODUCT INFORMATION

Adult Band Model #: 4006 Vinyl Band

VINYL

- Soft vinyl with snap closure and wave.
- Latex free.
- Allows for written information and for imprinting and label applications.

Adult Armband: 9.750" Long and 1.000" Wide
Patient Information Area: 2.500" Long and 1.000" Wide

Product No.	Colour	Product Dimensions
4006-WH	White ○	9.75" (length) x 1.00" (width)
4006-RE	Red ●	9.75" (length) x 1.00" (width)
4006-YE	Yellow ●	9.75" (length) x 1.00" (width)
4006-GR-L	Light Green ●	9.75" (length) x 1.00" (width)
4006-BL-L	Light Blue ●	9.75" (length) x 1.00" (width)
4006-PU	Purple ●	9.75" (length) x 1.00" (width)
4006-PI	Pink ●	9.75" (length) x 1.00" (width)
4006-OR	Orange ●	9.75" (length) x 1.00" (width)

Functional Equivalent for (by Current PDC Supplier Code):

○	655-11-PDJ, 940-11-PDJ
●	625-16-PDJ, 655-16-PDJ, 940-16-PDJ
●	655-14-PDJ
●	520P-41-PDM, 655-15-PDJ, 940-15-PDJ
●	625-13-PDJ, 655-13-PDJ
●	655-43-PDJ
●	655-17-PDJ



Notes:

Poly Bands

Tamper evident

Water resistant/clear adhesive shield

Requires no specific printer hardware

Large-area for patient demographic information and barcodes (1D & 2D) label to be applied

Multiple colour choices

MEDIREX ID BANDS, LABELS & PAPER

PRODUCT INFORMATION

Adult Band with Snap Closure

Model #: 4021

Poly Band

POLYESTER

- Polyester with extra-wide face, clear adhesive shield and snap closure.
- Allows for label applications, and 1D & 2D bar coding.
- 4021-BL-L-DR has preprinted DNR

Adult Armband: 11.75" Long and 1.25" Wide

Patient Information Area: 3.375" Long and 1.25" Wide

Product No.	Colour		Product Dimensions
4021-WH	White	○	11.75" (length) x 1.25" (width)
4021-RE	Red	●	11.75" (length) x 1.25" (width)
4021-BL-L	Light Blue	●	11.75" (length) x 1.25" (width)
4021-BL-L-DR	Light Blue	●	11.75" (length) x 1.25" (width)
4021-PU	Purple	●	11.75" (length) x 1.25" (width)
4021-OR	Orange	●	11.75" (length) x 1.25" (width)

Functional Equivalent for (by Current PDC Supplier Code):

○	5080-11-PDM, 5090-11-PDM, 5090-11-PDM-I
●	5080-16-PDM, 5090-16-PDM
●	5090-13-PDM
●	5080-13-PDM
●	5080-33-PDM, 5090-33-PDM
●	5080-17-PDM, 5090-17-PDM

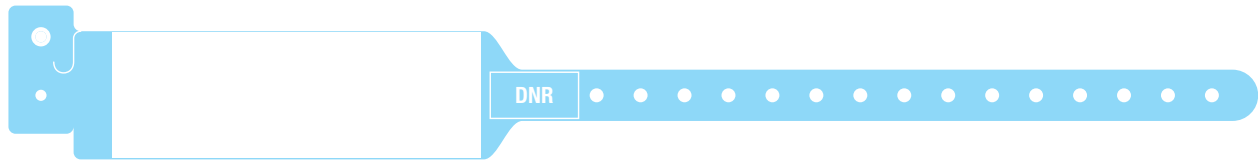

Notes:

MEDIREX ID BANDS, LABELS & PAPER

PRODUCT INFORMATION

Paediatric Band with Snap Closure

Model #: 4040

Poly Band

POLYESTER

- Polyester with clear adhesive shield and snap closure.
- Allows for label applications, and 1D & 2D bar coding.

Paediatric Armband: 10.75" Long and 1.125" Wide
Patient Information Area: 2.5" Long and 1.25" Wide

Product No.	Colour		Product Dimensions
4040-WH	White	○	10.75" (length) x 1.25" (width)
4040-RE	Red	●	10.75" (length) x 1.25" (width)

Functional Equivalent for (by Current PDC Supplier Code):

○	5090-11
●	5090-16

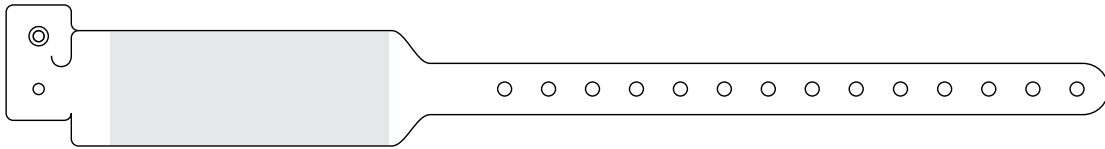

Notes:

EcoPaper Bands

Tamper evident

Requires no specific printer hardware

Large-area for patient demographic information and barcodes (1D & 2D) label to be applied

Multiple colour choices

MEDIREX ID BANDS, LABELS & PAPER

PRODUCT INFORMATION

Adult Band Model #: 4002 *EcoPaper Band*

PAPER

- Tyvek soft, durable and tamper-evident closure.
- Latex and Phthalate-Free.
- Allows for written information and for imprinting and label applications.

—

Adult Armband: 9.75" Long and 1.0" Wide

Patient Information Area: 2.5" Long and 1.0" Wide

Product No.	Colour	Product Dimensions
4002-WH	White	9.75" (length) x 1.00" (width)
4002-RE	Red	9.75" (length) x 1.00" (width)
4002-YE	Yellow	9.75" (length) x 1.00" (width)
4002-GR-D	Dark Green	9.75" (length) x 1.00" (width)
4002-BL-L	Light Blue	9.75" (length) x 1.00" (width)
4002-PU	Purple	9.75" (length) x 1.00" (width)
4002-PI	Pink	9.75" (length) x 1.00" (width)
4002-OR	Orange	9.75" (length) x 1.00" (width)

Functional Equivalent for (by Current PDC Supplier Code):

○	3000-11-PDR, 3080-11-PDR
●	3000-16-PDR, 3080-16-PDR
●	3000-14-PDR, 3080-14-PDR
●	2008-75-PDR, 3000-22-PDR, 3080-22-PDR
●	3000-13-PDR, 3080-13-PDR
●	2008-43-PDR
●	3000-17-PDR, 3080-17-PDR



Notes:

Carbonless Paper

Priced Competitively

Varying sizes and layout to accommodate
all healthcare processes

Variety of Colour Combinations

Variety of Sheets to a Set

Designed for use in any Laser Printer

Designed for Easy Insertion into laser printer trays

Sure-thru Transfer of handwritten notes

Compatible with Medirex Print Server Software

MEDIREX ID BANDS, LABELS & PAPER

PRODUCT INFORMATION

2-Part Carbonless Sheets Model #: 7902 *Carbonless Paper*

LASER PRINTABLE

- White & Yellow Sets
- 5 Hole Punches for Chart & Health Records
- Designed for use in any Laser Printer
- Designed for Easy Insertion into laser printer trays
- Sure-thru Transfer of handwritten notes

Coating: White – Back, Yellow – Front
Product Dimensions: 11.000" Long and 8.500" Wide

Product No.	Colour	Current Supplier Code
7902	White ○	11" (length) x 8.5" (width)
	Yellow ●	

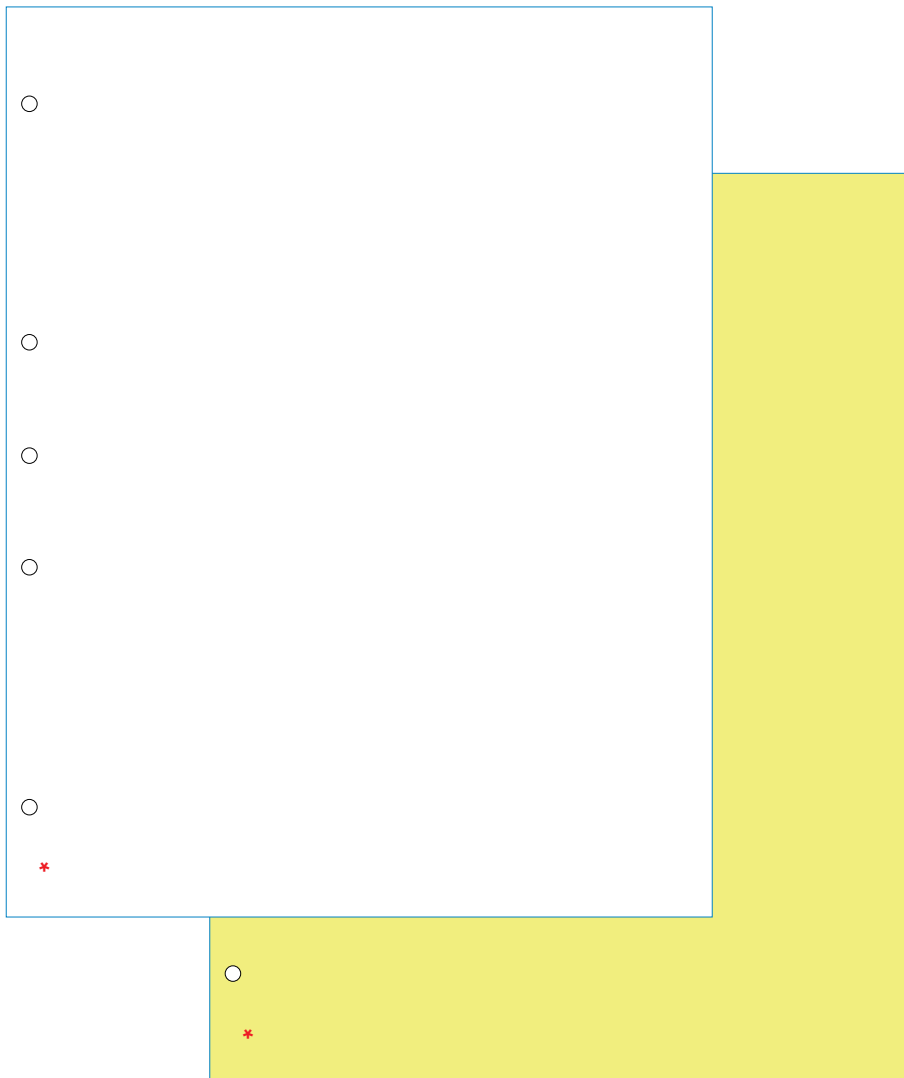

Notes:

MEDIREX ID BANDS, LABELS & PAPER

PRODUCT INFORMATION

3-Part Carbonless Sheets

Model #: 7903
Carbonless Paper

LASER PRINTABLE

- White, Yellow, & Pink Sets
- 5 Hole Punches for Chart & Health Records
- Designed for use in any Laser Printer
- Designed for Easy Insertion into laser printer trays
- Sure-thru Transfer of handwritten notes

Coating: White – Back, Yellow – Front & Back, Pink – Front
 Product Dimensions: 11.000" Long and 8.500" Wide

Product No.	Colour	Current Supplier Code
7903	White ○	11" (length) x 8.5" (width)
	Yellow ●	
	Pink ●	

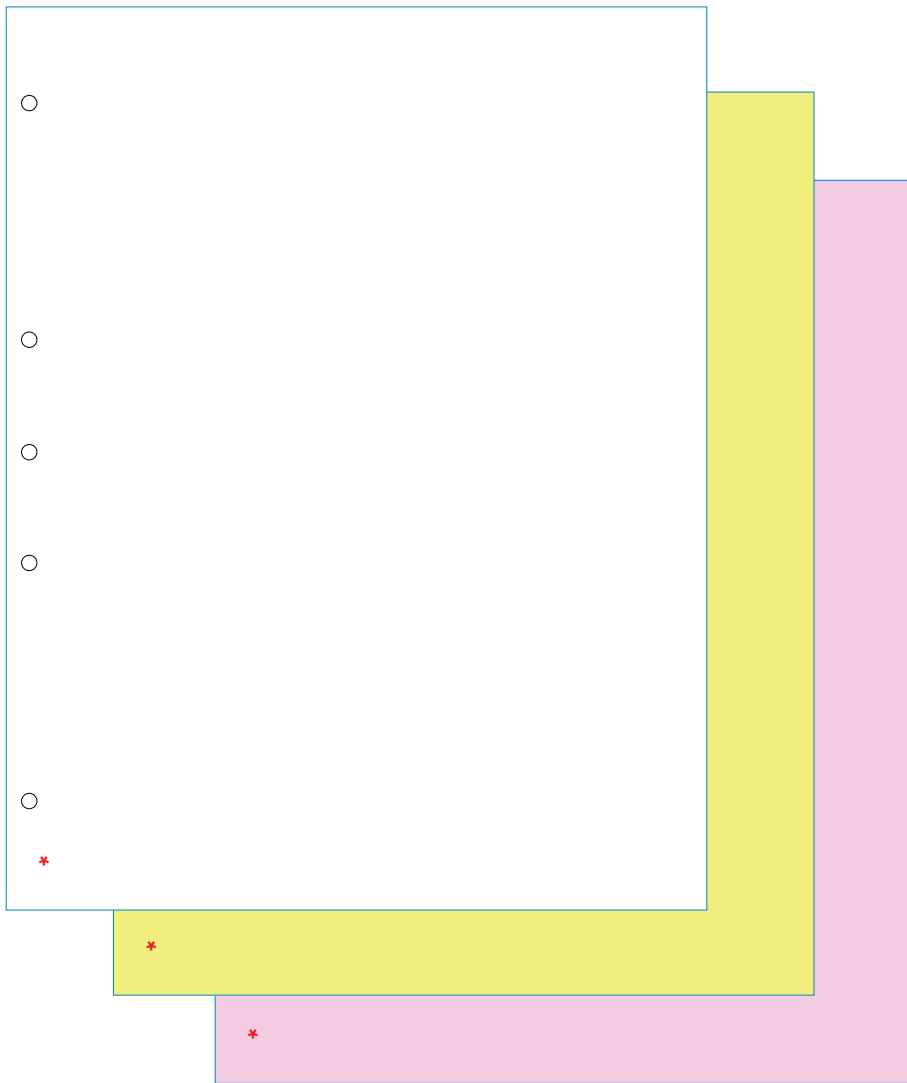

Notes:

MEDIREX ID BANDS, LABELS & PAPER

PRODUCT INFORMATION

2-Part Carbonless Sheets Model #: 7904 *Carbonless Paper*

LASER PRINTABLE

- White & Yellow Sets
- 5 Hole Punches for Chart & Health Records
- Top 0.625" Perforated stub for stapling
- Easy Organization with Numbered Sets
- Designed for use in any Laser Printer
- Designed for Easy Insertion into laser printer trays
- Sure-thru Transfer of handwritten notes

Coating: White – Back, Yellow – Front

Product Dimensions: 11.625" Long and 8.500" Wide

Product No.	Colour	Current Supplier Code
7904	White ○	11.625" (length) x 8.5" (width)
	Yellow ●	

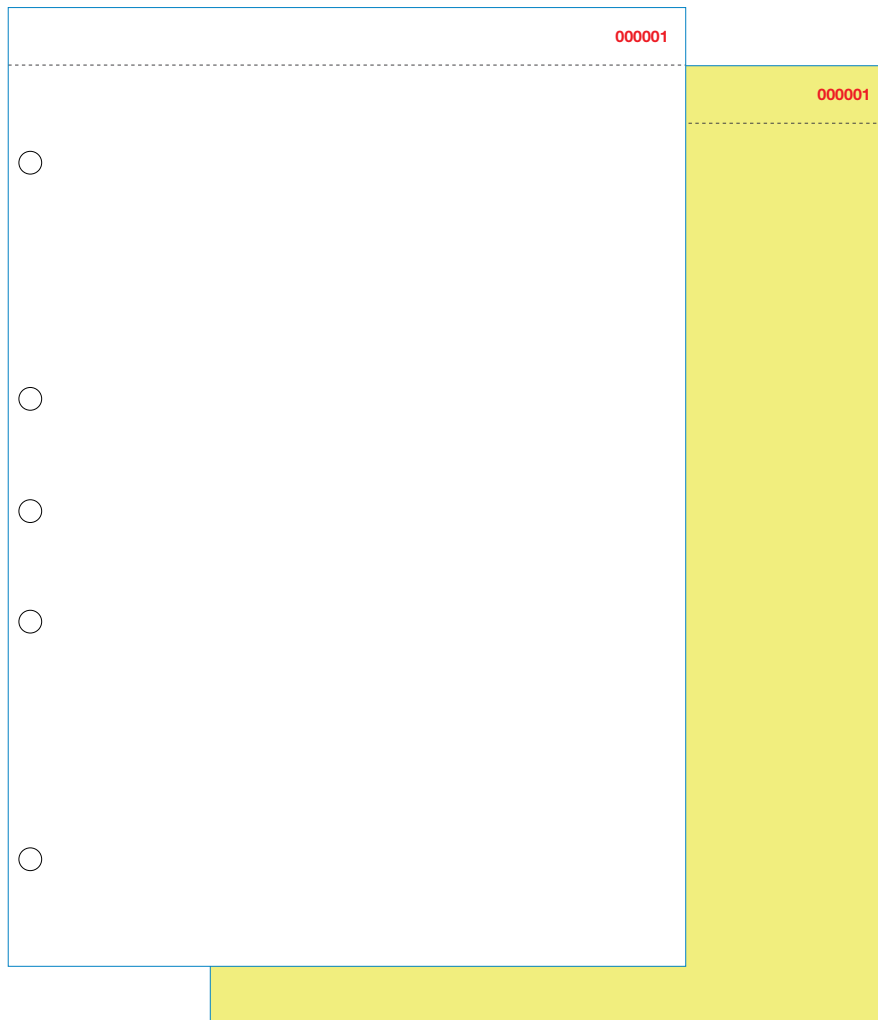

Notes:

MEDIREX ID BANDS, LABELS & PAPER

PRODUCT INFORMATION

3-Part Carbonless Sheets

Model #: 7905
Carbonless Paper

LASER PRINTABLE

- White & Yellow Sets
- 5 Hole Punches for Chart & Health Records
- Top 0.625" Perforated stub for stapling
- Easy Organization with Numbered Sets
- Designed for use in any Laser Printer
- Designed for Easy Insertion into laser printer trays
- Sure-thru Transfer of handwritten notes

Product No.	Colour	Current Supplier Code
7905	White ○	11.625" (length) x 8.5" (width)
	Yellow ●	
	Pink ●	

Coating: White – Back, Yellow – Front

Product Dimensions: 11.625" Long and 8.500" Wide

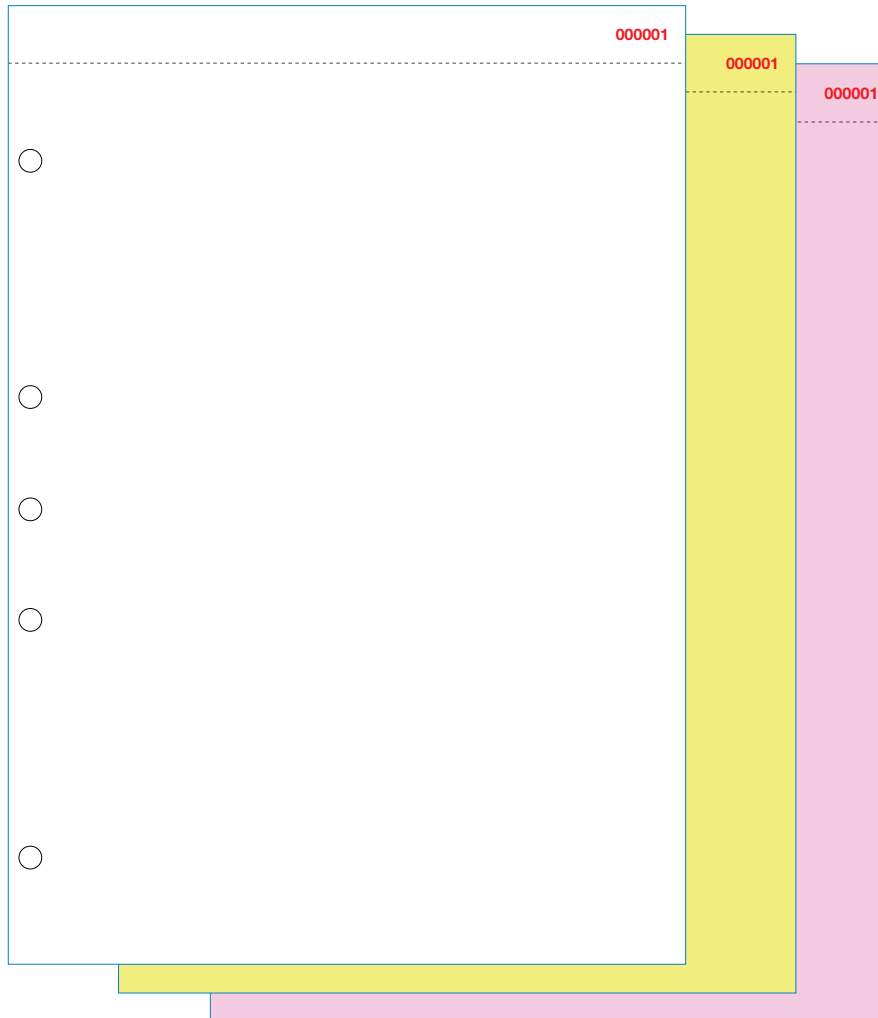

Notes:

MEDIREX ID BANDS, LABELS & PAPER

PRODUCT INFORMATION

Single-Part Carbonless Sheet

Model #: 7915
Carbonless Paper

LASER PRINTABLE

- Pure White sheets Only
- 5 Hole Punches for Chart & Health Records
- Top-left Perforation for easy stapling of parts
- Red "CFB" denotes print side
- Designed for use in any Laser Printer
- Designed for Easy Insertion into laser printer trays
- Sure-thru Transfer of handwritten notes

Coating: Front and Back (CFB)

Product Dimensions: 11.000" Long and 8.500" Wide

Product No.	Colour		Current Supplier Code
7915	White	○	11 " (length) x 8.5" (width)

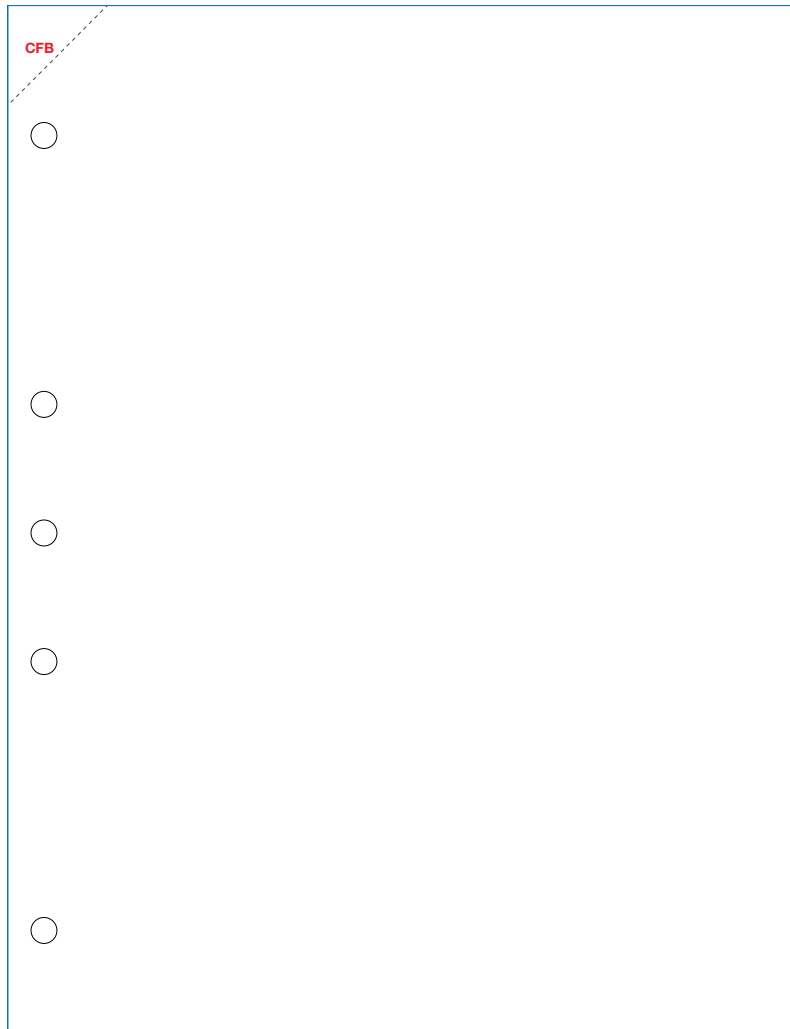

Notes:

MEDIREX ID BANDS, LABELS & PAPER: POSITIVE PATIENT IDENTIFICATION

499 Queen Street East
Toronto, Ontario M5A 1V1
Phone: +1 (416) 363-9313
Toll Free: 1 (800) 387-9848
www.medirexsys.com
www.positivepatient.ca